

MAN

All product images are indicative only



Single-channel open impeller



General characteristics

Single-channel open impeller	
motor power	1,1 ÷ 4,1 kW
poles	2 / 4 / 6
discharge	GAS 2 1/2" vertical DN65 ÷ DN150 horizontal
free passage	40 ÷ 100 mm
max flow rate	53.9 l/s
max head	30.2 m

Electromechanical assembly

Electromechanical assembly in GJL-250 cast iron, for submerged operation. Seal set comprising 2 (two) opposing silicon carbide mechanical seals in inspectable oil sump. Ecological dry motor. Series available in ATEX explosion-proof version.

Applications

Used with unstrained soiled biological wastewaters and sewage and for civil lifting applications. It is thus ideal for wastewater treatment plants, sewer systems, livestock farms, industry and agriculture. The pump is also available in explosion-proof version with ATEX certification. This series is prefitted for installation of the ZENIT cooling system for dry or semi-submerged installation.

Construction materials

Case	Cast iron EN-GJL 250
Impeller	Cast iron EN-GJL-250
Nuts and bolts	Stainless steel - Class A2-70
Standard gasket	Rubber - NBR
Shaft	Stainless steel - AISI 420
Cooling jacket	Stainless steel - AISI 304
Paint type	Ecological bicomponent epoxy (medium thickness 150 µm)
Set of standard mechanical seals	Two silicon carbide mechanical seals (2SiC)

Operating limits

Maximum operating temperature	40 °C
PH of treated fluid	6 ÷ 14
Viscosity of treated fluid	1 mm ² /s
Maximum immersion depth	20 m
Density of treated fluid	1 Kg/dm ³
Maximum acoustic pressure	70 dB
max starts per hour	30



Cooling system

Dry installation available using the cooling jacket (see details to page 17)



Cable gland

Cable gland system to guarantee perfect water-tightness. The GAS thread ring-nut can be removed to fix a rigid or flexible duct to the cable gland to protect the power supply cable



Mechanical seals

Two silicon carbide (SiC) mechanical seals in oil sump



Oil sump

Large oil sump to guarantee longer mechanical seal lifetime



Drive shaft

A special bronze bush coupled to the tapered shaft enables quick and easy impeller clearance adjustment, thus maintaining the pump's hydraulic specifications



Anti-clogging system

The special design of the hydraulic part ensures the expulsion of suspended solids and prevents fouling of the impeller

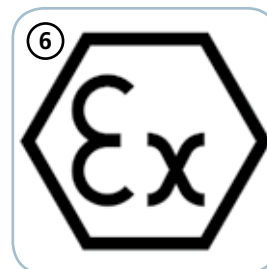

EX

Models available on request with ATEX certification, suitable for installation in the presence of potentially explosive gases, powders and liquids

CE 0496 Ex II 2GD Ex db k c IIB T5 Ex tb IIIC T100°C IP68

MAN

Models with vertical GAS 2 1/2" threaded discharge - 2 poles

Performances

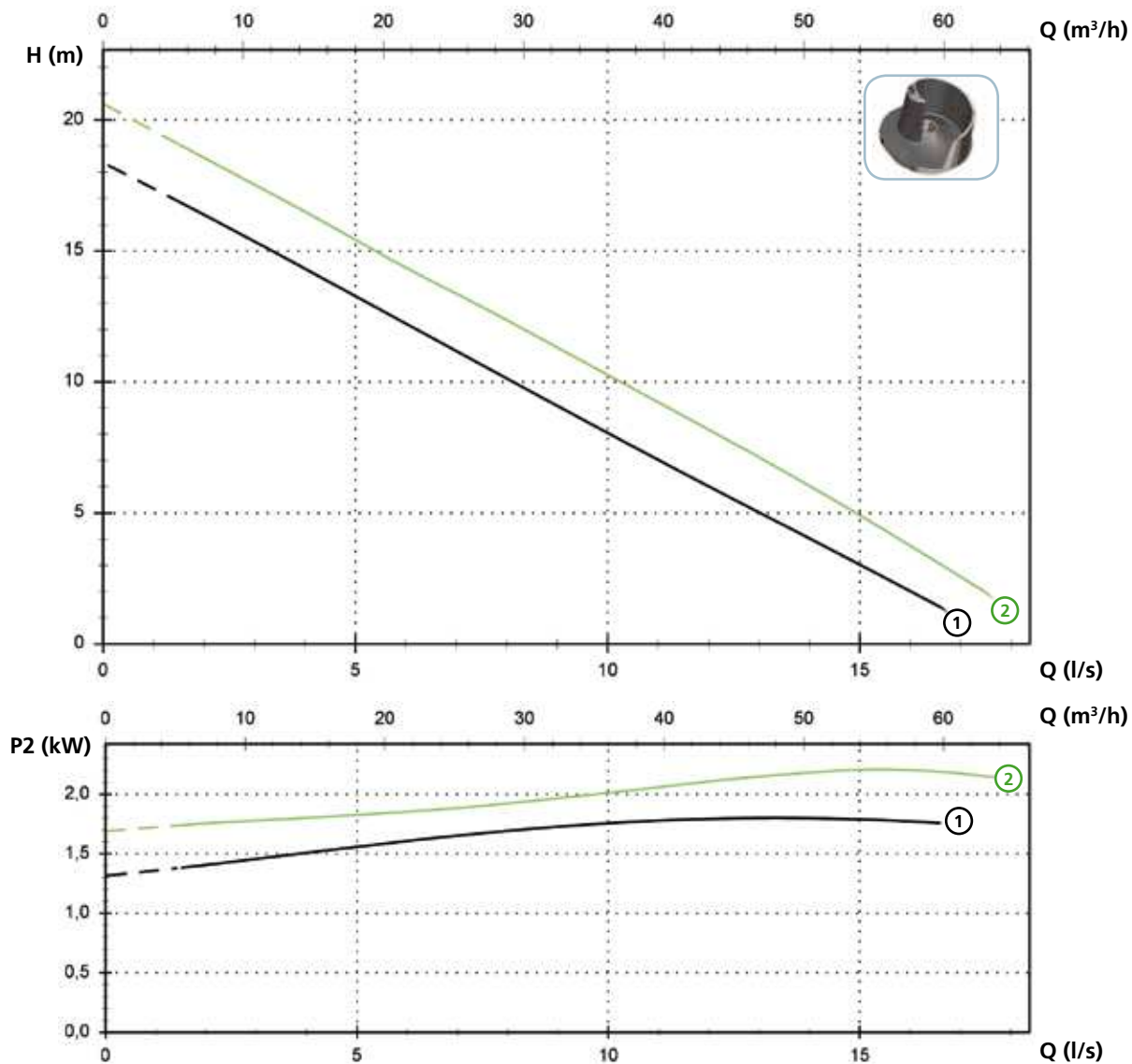

Technical data

	V	Phases	P1 (kW)	P2 (kW)	A	Rpm	Start	Ø	Cable (*)	Free passage
① MAN 250/2/G65V A1DM/50	230	1	2.8	1.8	12.5	2900	Dir	G 2 1/2"	A - B	40 mm
① MAN 250/2/G65V A1DT/50	400	3	2.5	1.8	4.3	2900	Dir	G 2 1/2"	A - B	40 mm
② MAN 300/2/G65V A1DT/50	400	3	2.9	2.2	5.1	2900	Dir	G 2 1/2"	A - B	40 mm

(*) A = 07RN-F 4G1.5+3x1 - 10 m (standard version). Electrical and mechanical features are equal to the cable H07RN-F
 B = NSSHOU-J 4G1.5+2x0.75 - 10 m (ATEX version)

Models with horizontal DN65 PN10-16 flanged discharge - 2 poles

Performances

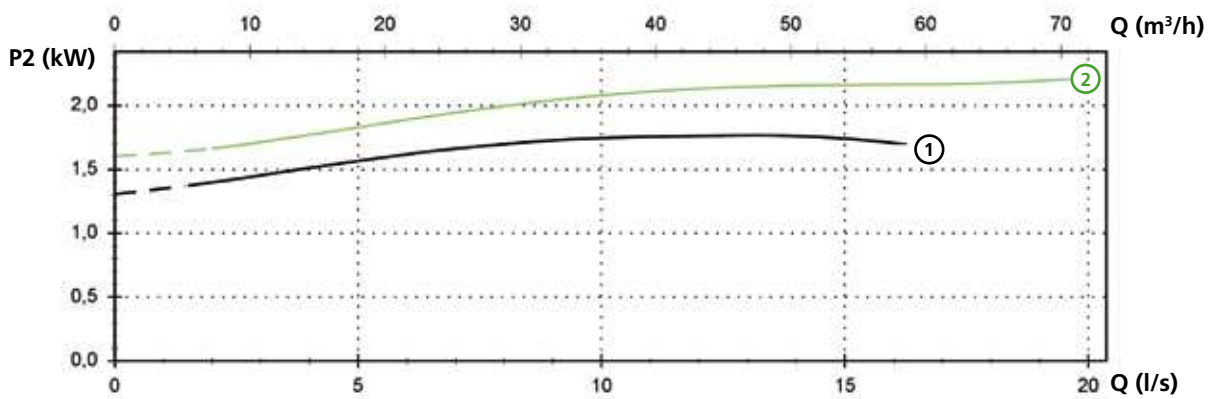
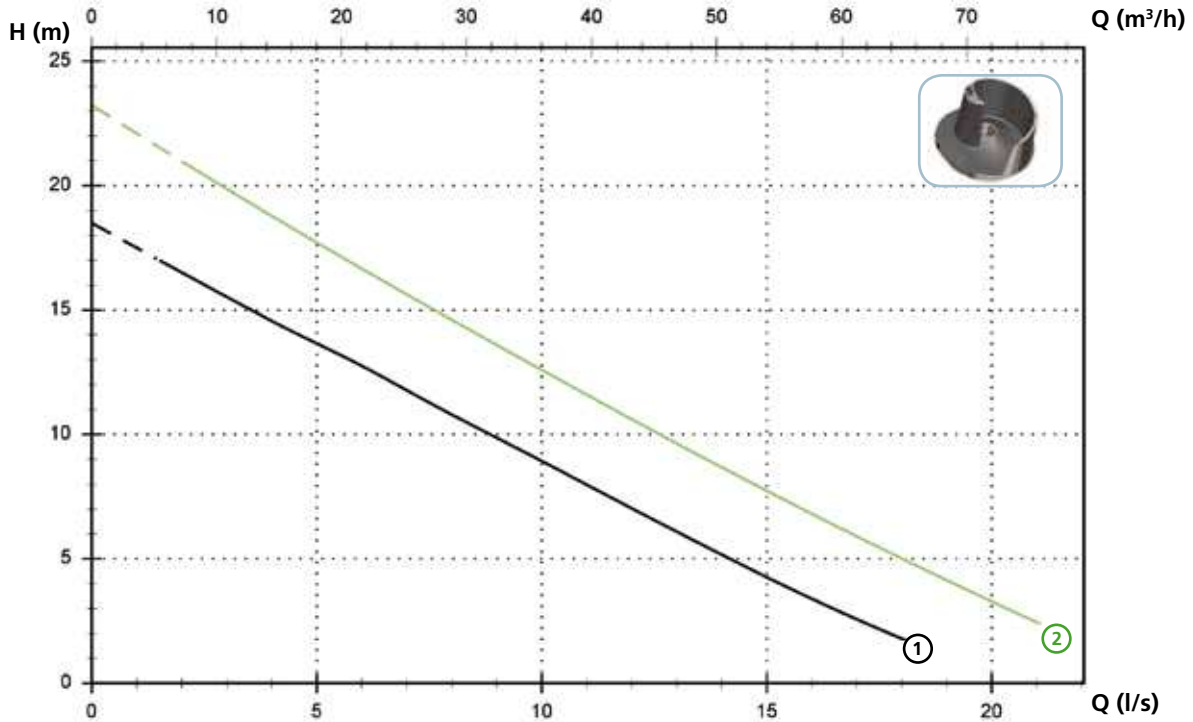

Technical data

	V	Phases	P1 (kW)	P2 (kW)	A	Rpm	Start	Ø	Cable (*)	Free passage
① MAN 250/2/65 A1DM/50	230	1	2.8	1.8	12.5	2900	Dir	DN65 PN10-16	A - B	40 mm
① MAN 250/2/65 A1DT/50	400	3	2.3	1.8	4.3	2900	Dir	DN65 PN10-16	A - B	40 mm
② MAN 300/2/65 A1DT/50	400	3	2.9	2.2	5.1	2900	Dir	DN65 PN10-16	A - B	40 mm

(*) A = 07RN-F 4G1.5+3x1 - 10 m (standard version). Electrical and mechanical features are equal to the cable H07RN-F
 B = NSSHOU-J 4G1.5+2x0.75 - 10 m (ATEX version)

MAN

Models with horizontal DN65 PN10-16 flanged discharge - 2 poles

Performances

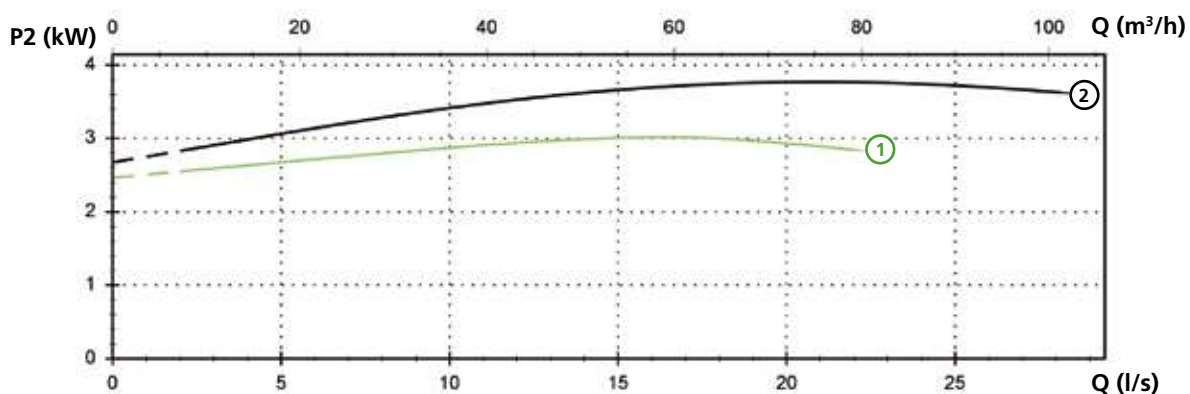
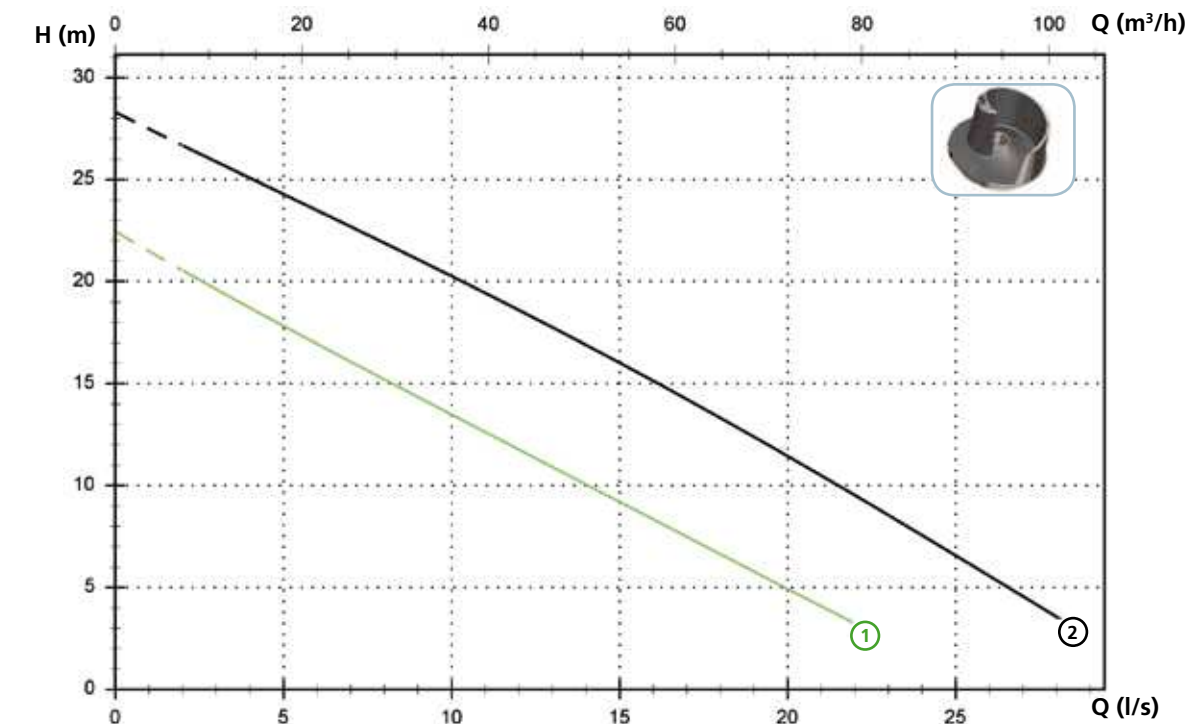

Technical data

	V	Phases	P1 (kW)	P2 (kW)	A	Rpm	Start	Ø	Cable (*)	Free passage	
①	MAN 400/2/65 A1FT/50	400	3	4.0	3	6.7	2900	Dir	DN65 PN10-16	A - C	45 mm
②	MAN 550/2/65 A1FT/50	400	3	5.0	4.1	8.7	2900	Dir	DN65 PN10-16	A - B	50 mm

(*) A = 07RN-F 4G1.5+3x1 - 10 m (standard version). Electrical and mechanical features are equal to the cable H07RN-F
 B = NSSHOU-J 4G1.5+2x0.75 - 10 m (ATEX version)
 C = NSSHOU-J 4G2.5+2x0.75 - 10 m (ATEX version)

Models with horizontal DN80 PN10-16 flanged discharge - 2 poles

Performances

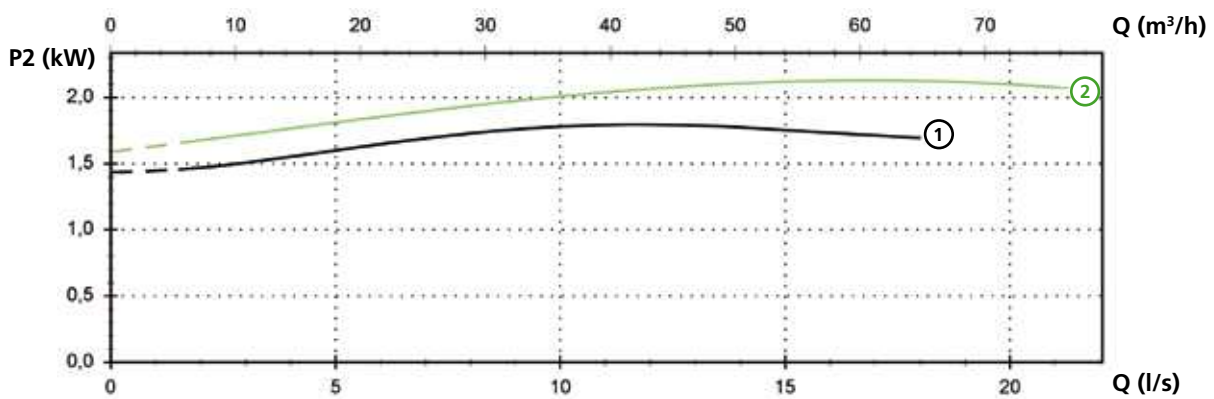
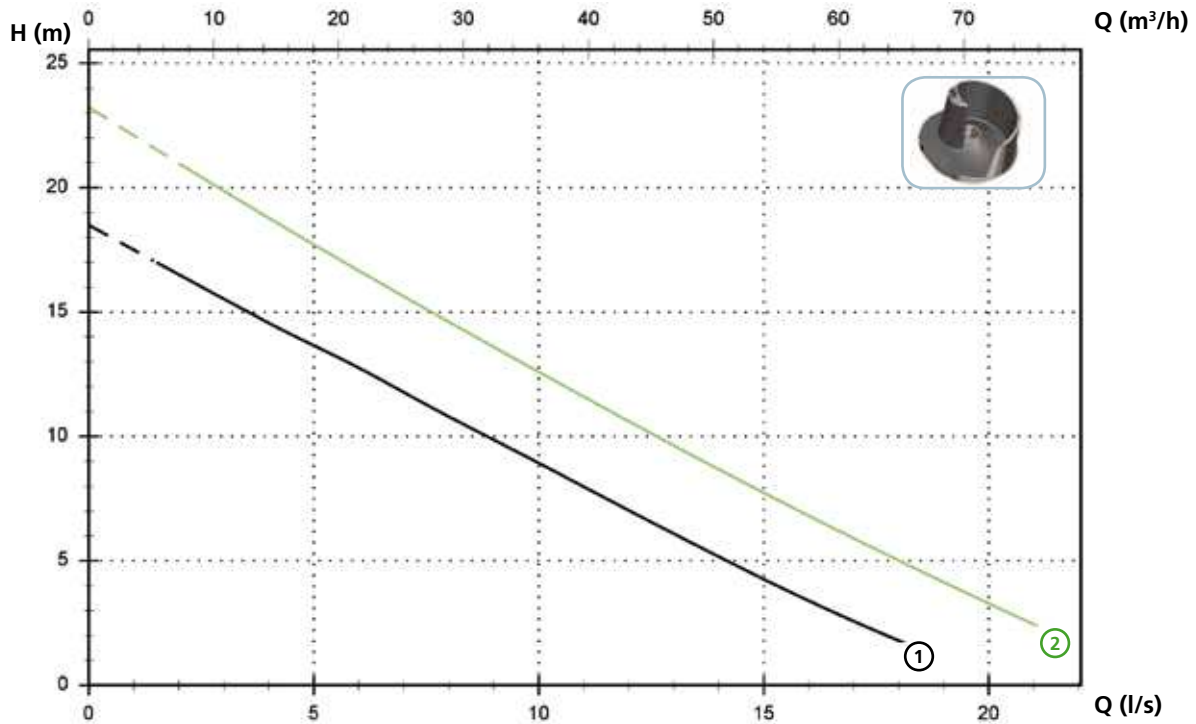

Technical data

	V	Phases	P1 (kW)	P2 (kW)	A	Rpm	Start	Ø	Cable (*)	Free passage
① MAN 250/2/80 A1DM/50	230	1	2.8	1.8	12.5	2900	Dir	DN80 PN10-16	A - B	40 mm
① MAN 250/2/80 A1DT/50	400	3	2.5	1.8	4.3	2900	Dir	DN80 PN10-16	A - B	40 mm
② MAN 300/2/80 A1DT/50	400	3	2.9	2.2	5.1	2900	Dir	DN80 PN10-16	A - B	40 mm

(*) A = 07RN-F 4G1.5+3x1 - 10 m (standard version). Electrical and mechanical features are equal to the cable H07RN-F
 B = NSSHOU-J 4G1.5+2x0.75 - 10 m (ATEX version)

MAN

Models with horizontal DN80 PN10-16 flanged discharge - 2 poles

Performances

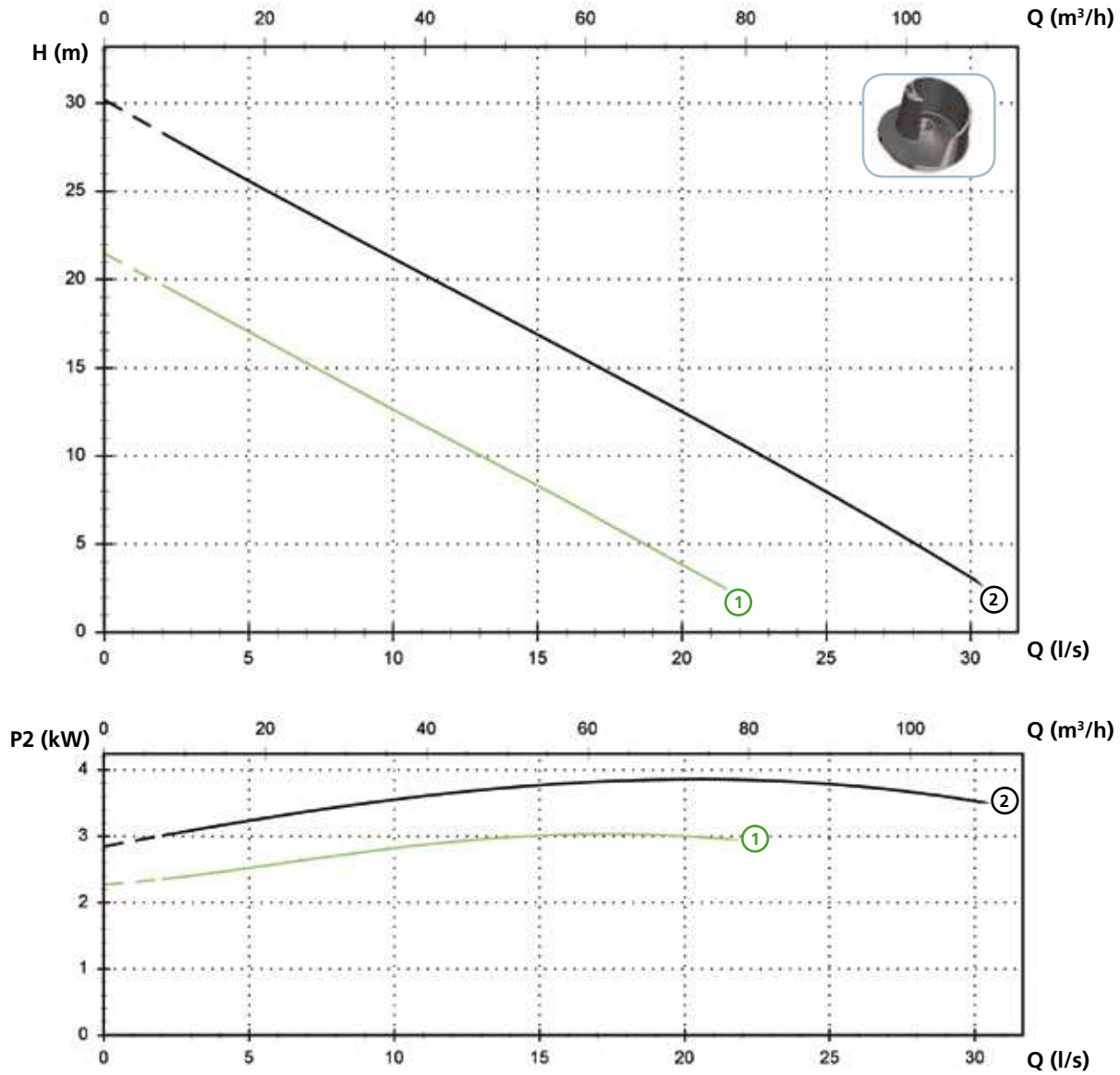

Technical data

	V	Phases	P1 (kW)	P2 (kW)	A	Rpm	Start	Ø	Cable (*)	Free passage	
①	MAN 400/2/80 A1FT/50	400	3	4.0	3	6.7	2900	Dir	DN80 PN10-16	A - B	40 mm
②	MAN 550/2/80 A1FT/50	400	3	5.0	4.1	8.7	2900	Dir	DN80 PN10-16	A - B	45 mm

(*) A = 07RN-F 4G1.5+3x1 - 10 m (standard version). Electrical and mechanical features are equal to the cable H07RN-F
 B = NSSHOU-J 4G2.5+2x0.75 - 10 m (ATEX version)

Models with horizontal DN100 PN10-16 flanged discharge - 2 poles

Performances

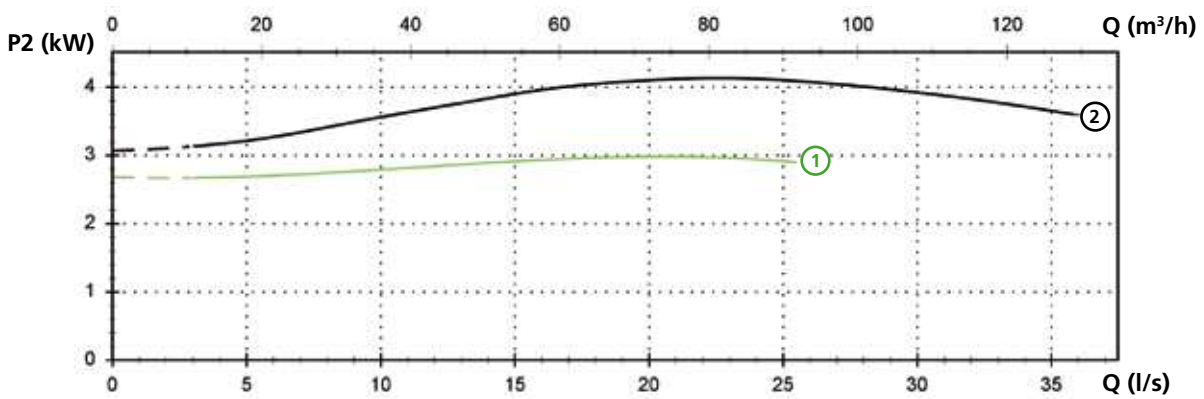
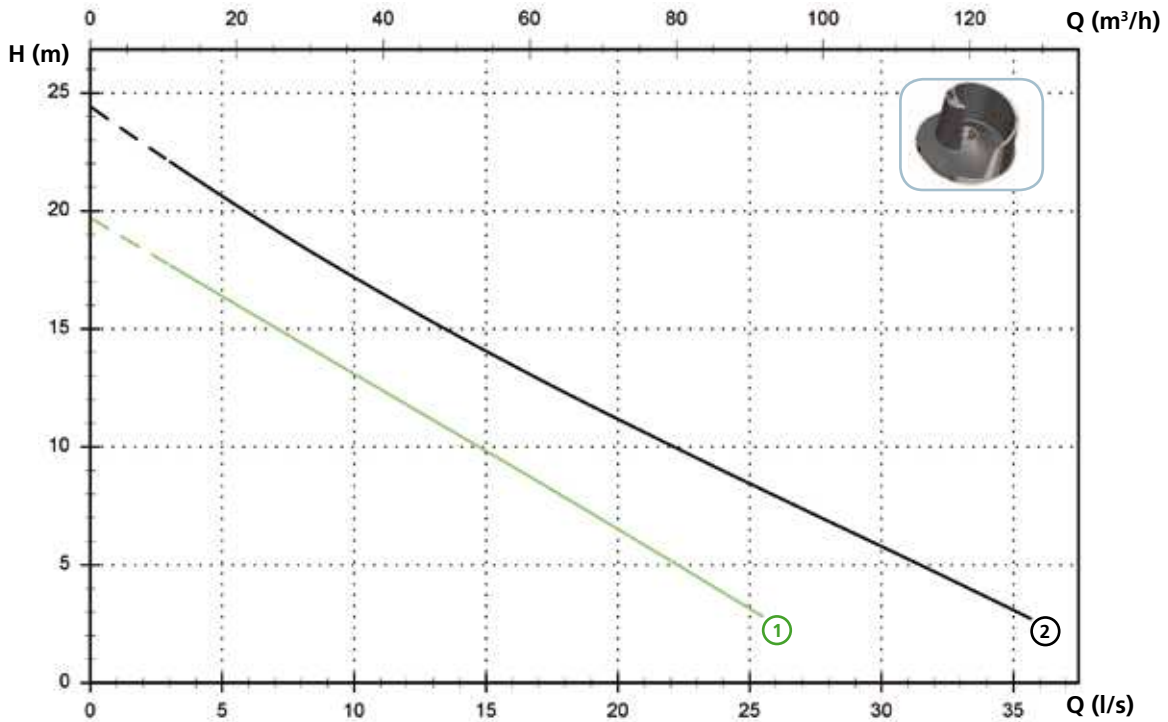

Technical data

	V	Phases	P1 (kW)	P2 (kW)	A	Rpm	Start	Ø	Cable (*)	Free passage	
①	MAN 400/2/100 A1FT/50	400	3	4.0	3	6.7	2900	Dir	DN100 PN10-16	A - B	50 mm
②	MAN 550/2/100 A1FT/50	400	3	5.0	4.1	8.7	2900	Dir	DN100 PN10-16	A - B	50 mm

(*) A = 07RN-F 4G1.5+3x1 - 10 m (standard version). Electrical and mechanical features are equal to the cable H07RN-F
 B = NSSHOU-J 4G2.5+2x0.75 - 10 m (ATEX version)

MAN

Models with horizontal DN80 PN10-16 flanged discharge - 4 poles

Performances

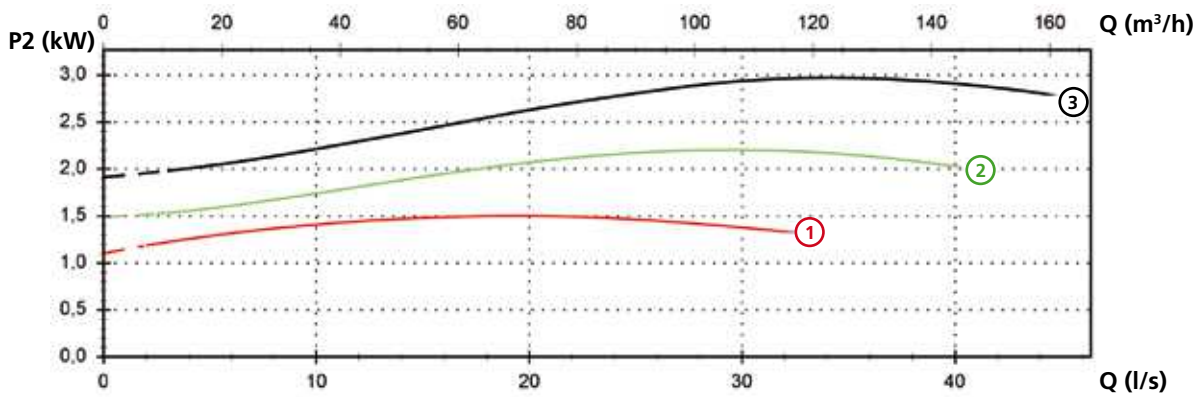
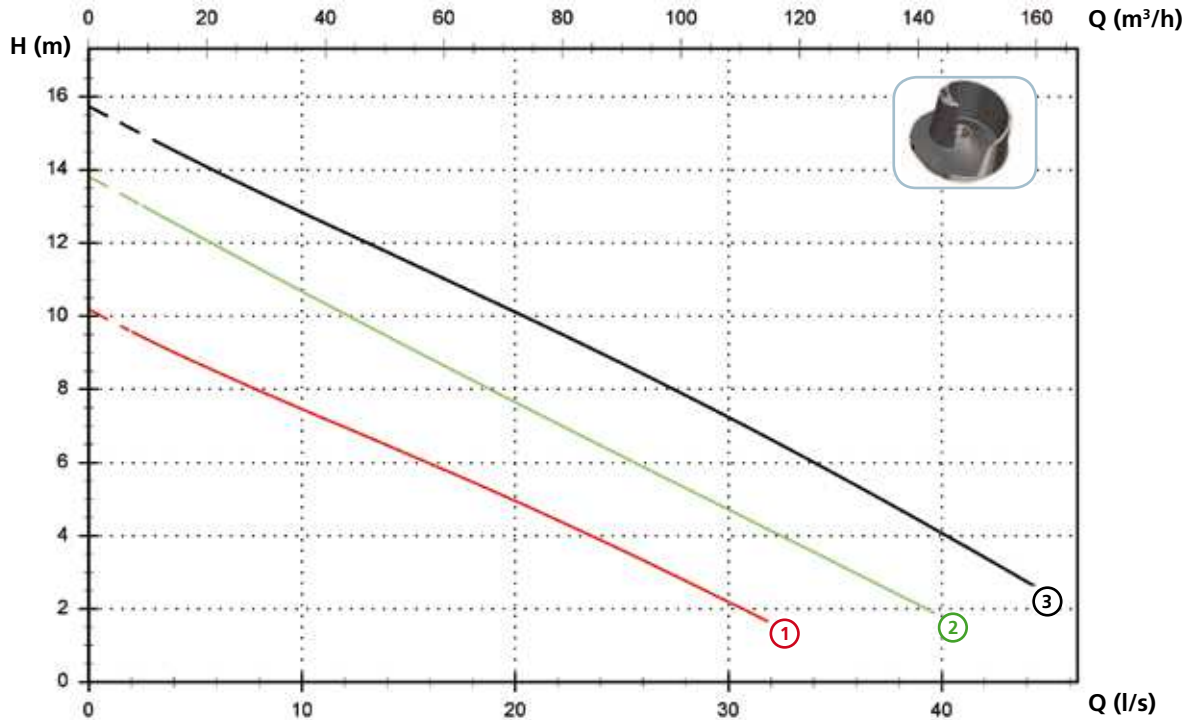

Technical data

	V	Phases	P1 (kW)	P2 (kW)	A	Rpm	Start	Ø	Cable (*)	Free passage	
①	MAN 200/4/80 A1DT/50	400	3	2	1.5	4.1	1450	Dir	DN80 PN10-16	A - B	80 mm
②	MAN 300/4/80 A1FT/50	400	3	2.9	2.2	5.8	1450	Dir	DN80 PN10-16	A - C	80 mm
③	MAN 400/4/80 A1FT/50	400	3	3.7	3	7.3	1450	Dir	DN80 PN10-16	A - C	80 mm

(*) A = 07RN-F 4G1.5+3x1 - 10 m (standard version). Electrical and mechanical features are equal to the cable H07RN-F
 B = NSSHOU-J 4G1.5+2x0.75 - 10 m (ATEX version)
 C = NSSHOU-J 4G2.5+2x0.75 - 10 m (ATEX version)

Models with horizontal DN100 PN10-16 flanged discharge - 4 poles

Performances

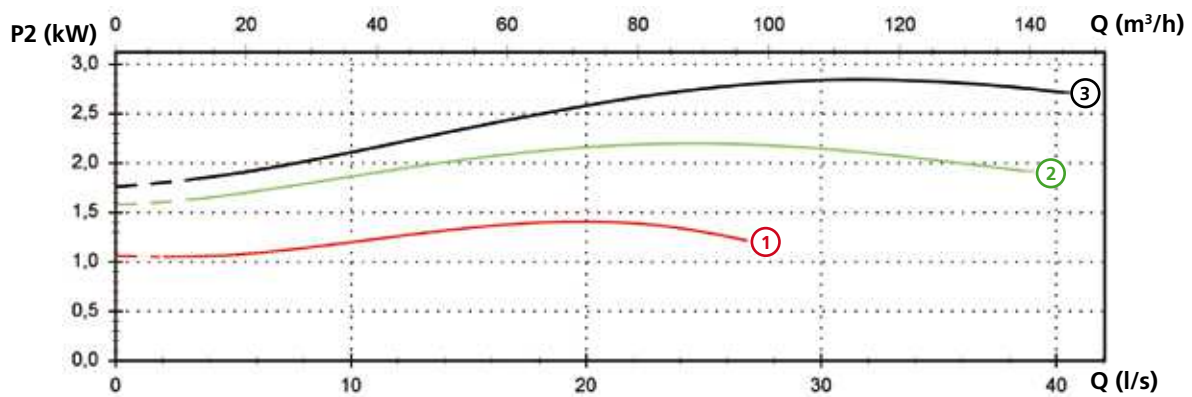
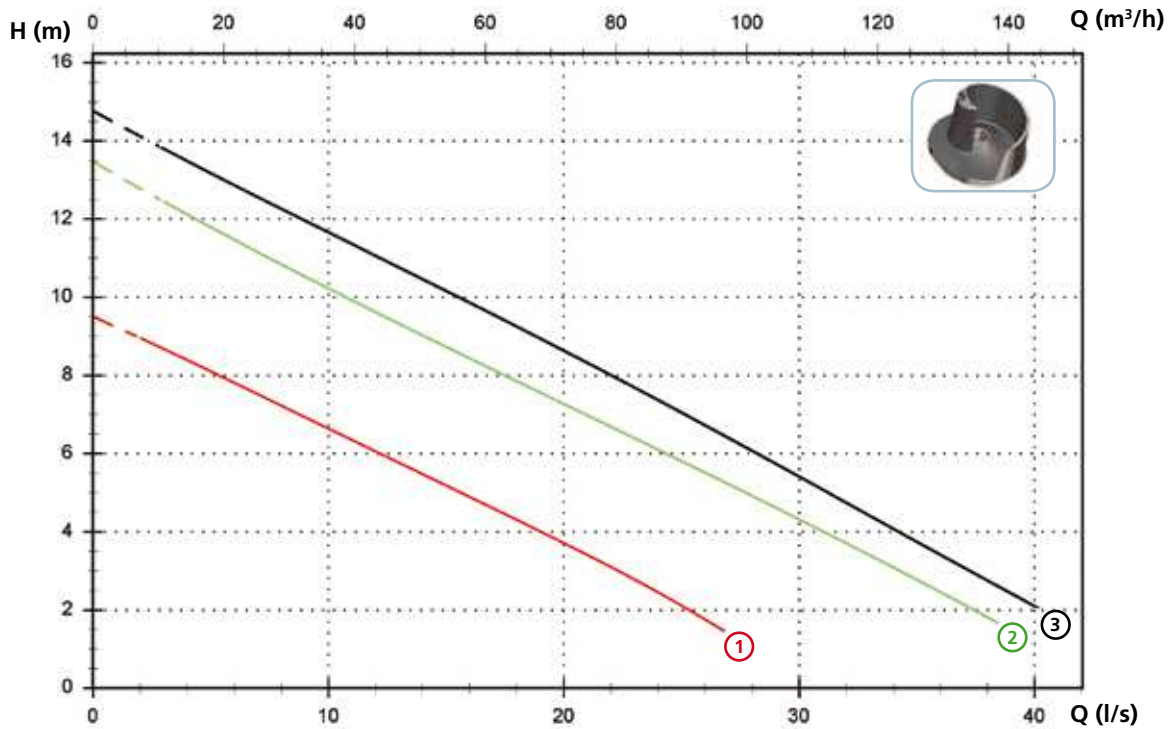

Technical data

	V	Phases	P1 (kW)	P2 (kW)	A	Rpm	Start	Ø	Cable (*)	Free passage	
①	MAN 200/4/100 A1DT/50	400	3	2	1.5	4.1	1450	Dir	DN100 PN10-16	A - B	80 mm
②	MAN 300/4/100 A1FT/50	400	3	2.9	2.2	5.8	1450	Dir	DN100 PN10-16	A - C	80 mm
③	MAN 400/4/100 A1FT/50	400	3	3.7	3	7.3	1450	Dir	DN100 PN10-16	A - C	80 mm

(*) A = 07RN-F 4G1.5+3x1 - 10 m (standard version). Electrical and mechanical features are equal to the cable H07RN-F
 B = NSSHOU-J 4G1.5+2x0.75 - 10 m (ATEX version)
 C = NSSHOU-J 4G2.5+2x0.75 - 10 m (ATEX version)

MAN

Models with horizontal DN80 PN10-16 flanged discharge - 6 poles

Performances

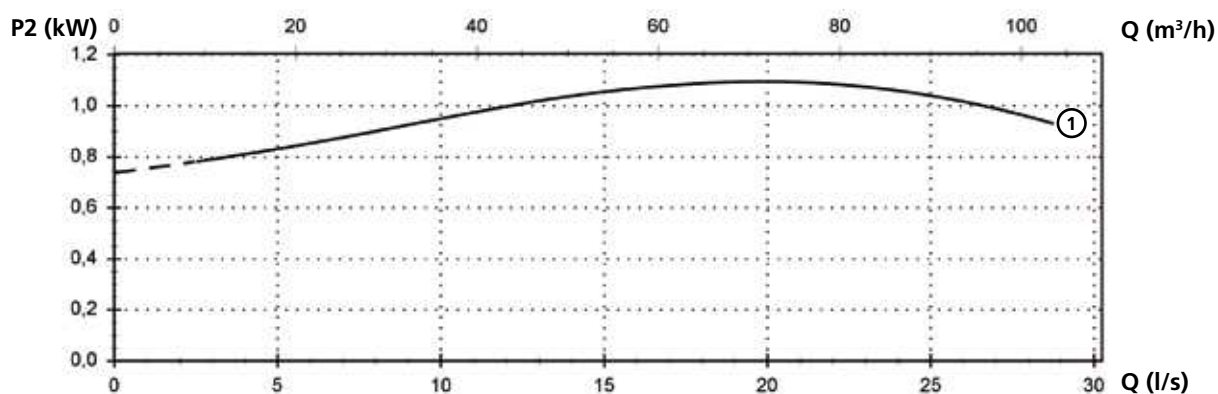
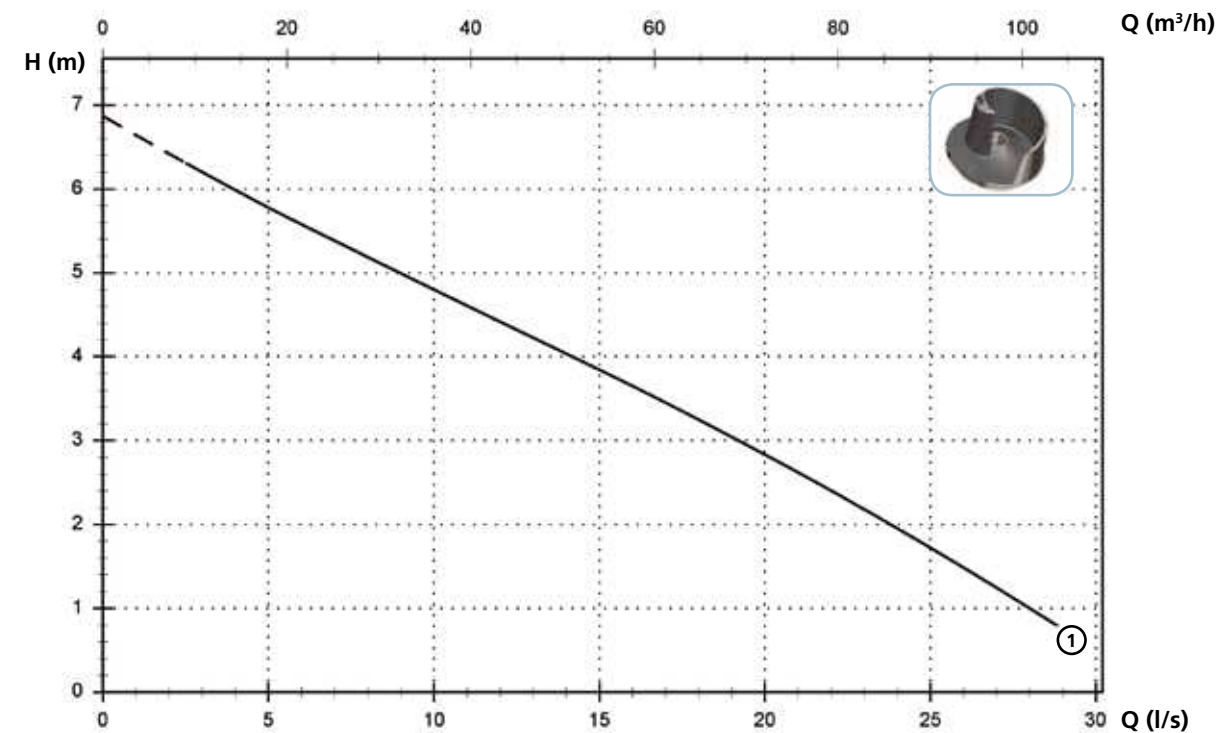

Technical data

	V	Phases	P1 (kW)	P2 (kW)	A	Rpm	Start	Ø	Cable (*)	Free passage	
①	MAN 150/6/80 A1DT/50	400	3	1.6	1.1	3.7	960	Dir	DN80 PN10-16	A - B	80 mm

(*) A = 07RN-F 4G1.5+3x1 - 10 m (standard version). Electrical and mechanical features are equal to the cable H07RN-F
 B = NSSHOU-J 4G1.5+2x0.75 - 10 m (ATEX version)

Models with horizontal DN100 PN10-16 flanged discharge - 6 poles

Performances

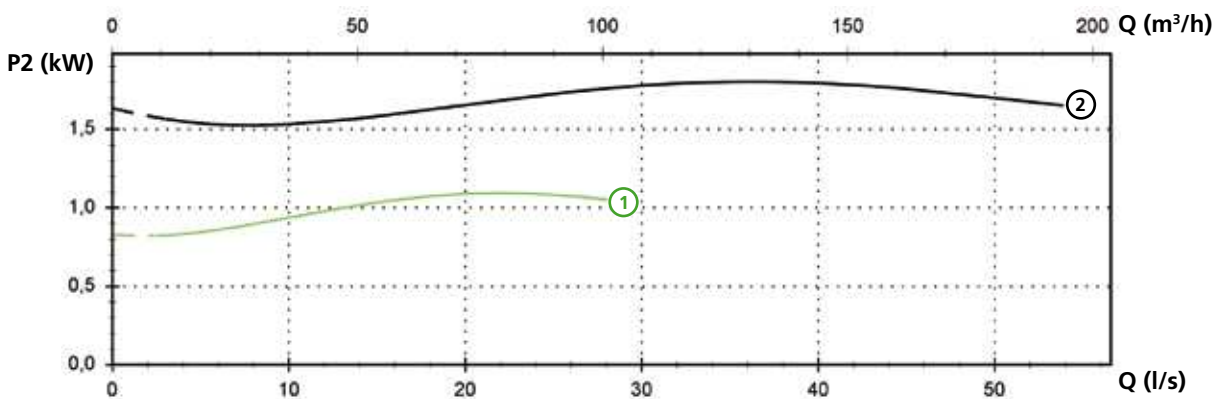
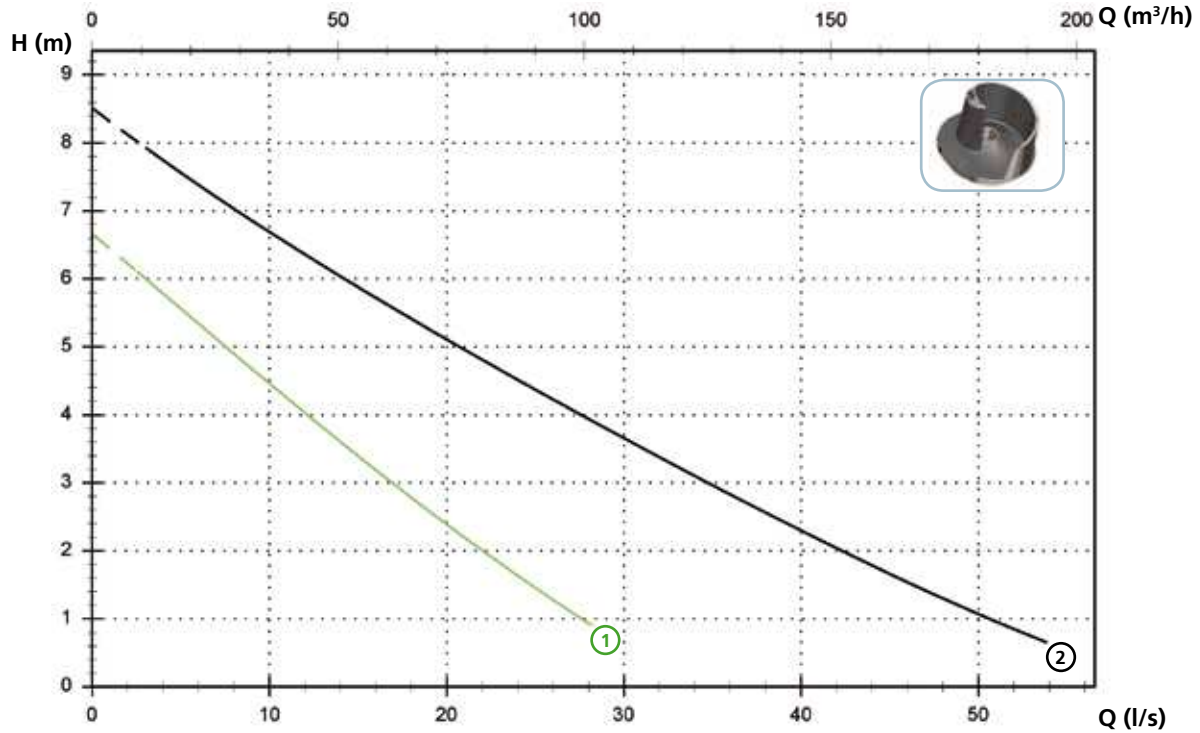

Technical data

	V	Phases	P1 (kW)	P2 (kW)	A	Rpm	Start	Ø	Cable (*)	Free passage	
①	MAN 150/6/100 A1DT/50	400	3	1.6	1.1	3.7	960	Dir	DN100 PN10-16	A - B	80 mm
②	MAN 250/6/100 A1FT/50	400	3	2.6	1.8	5.7	960	Dir	DN100 PN10-16	A - C	100 mm

(*) A = 07RN-F 4G1.5+3x1 - 10 m (standard version). Electrical and mechanical features are equal to the cable H07RN-F
 B = NSSHOU-J 4G1.5+2x0.75 - 10 m (ATEX version)
 C = NSSHOU-J 4G2.5+2x0.75 - 10 m (ATEX version)

MAN

Models with horizontal DN150 PN10-16 flanged discharge - 6 poles

Performances

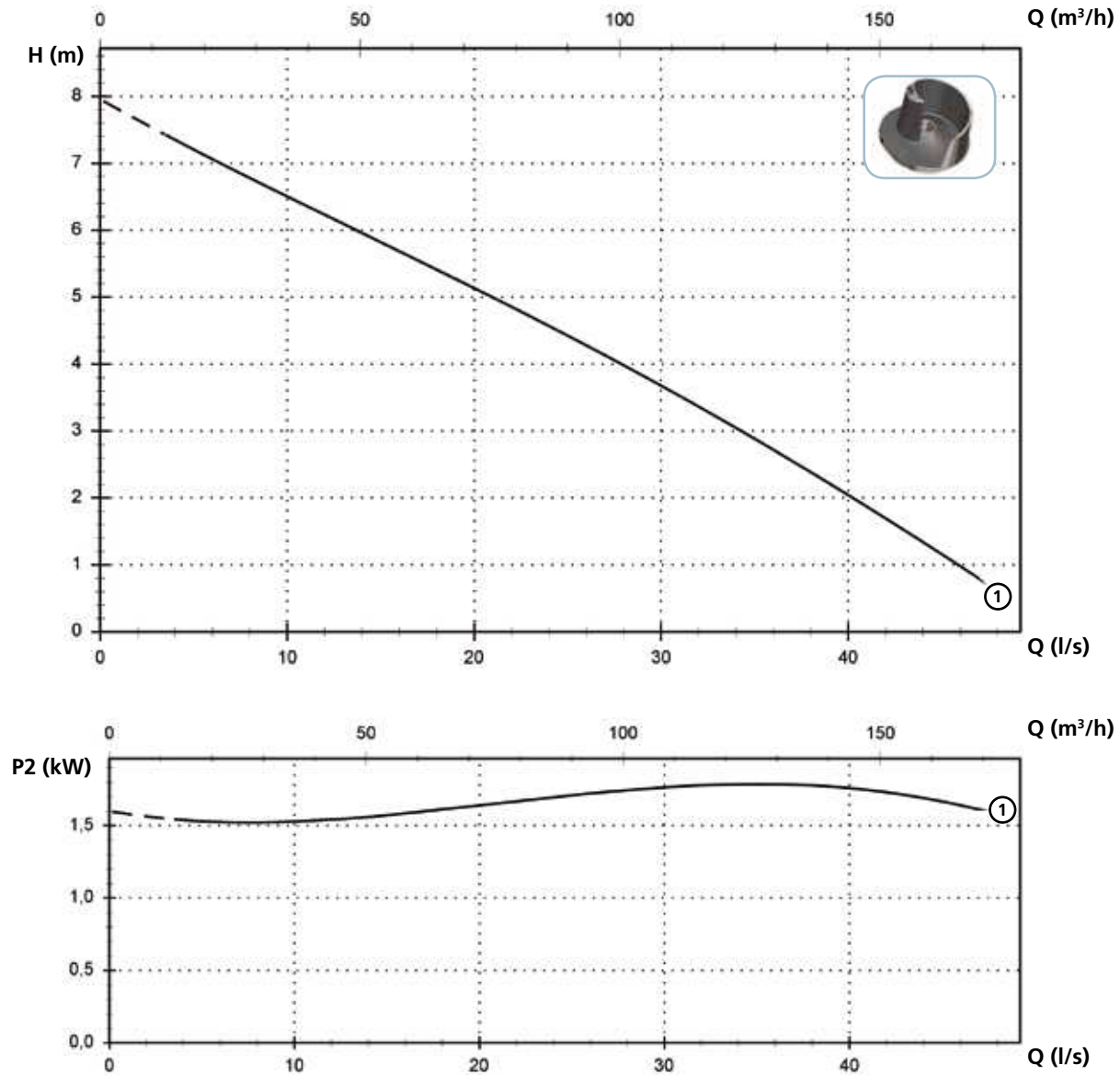

Technical data

	V	Phases	P1 (kW)	P2 (kW)	A	Rpm	Start	Ø	Cable (*)	Free passage	
①	MAN 250/6/150 A1FT/50	400	3	2.6	1.8	5.7	960	Dir	DN150 PN10-16	A - B	100 mm

(*) A = 07RN-F 4G1.5+3x1 - 10 m (standard version). Electrical and mechanical features are equal to the cable H07RN-F
 B = NSSHOU-J 4G2.5+2x0.75 - 10 m (ATEX version)



Versions available

(Key to versions on page 16)

	Electrical variants											Cooling				Mechanical seals			
	N A E	T	T C D	T C D T	T C D G T	T C G	T C S T	T C S G T	T S	T R	T R G	N	CC CCE	FT	C G F T	2SIC	SICM	SICAL	2SICAL
MAN 250/2/G65V A1DM/50			●								●	●			●				
MAN 250/2/G65V A1DT/50	●								●		●	●			●				
MAN 300/2/G65V A1DT/50	●								●		●	●			●				
MAN 250/2/65 A1DM/50			●								●	●			●				
MAN 250/2/65 A1DT/50	●								●		●	●			●				
MAN 300/2/65 A1DT/50	●								●		●	●			●				
MAN 400/2/65 A1FT/50	●								●		●	●			●				
MAN 550/2/65 A1FT/50	●								●		●	●			●				
MAN 250/2/80 A1DM/50			●								●	●			●				
MAN 250/2/80 A1DT/50	●								●		●	●			●				
MAN 300/2/80 A1DT/50	●								●		●	●			●				
MAN 400/2/80 A1FT/50	●								●		●	●			●				
MAN 550/2/80 A1FT/50	●								●		●	●			●				
MAN 400/2/100 A1FT/50	●								●		●	●			●				
MAN 550/2/100 A1FT/50	●								●		●	●			●				
MAN 200/4/80 A1DT/50	●								●		●	●			●				
MAN 300/4/80 A1FT/50	●								●		●	●			●				
MAN 400/4/80 A1FT/50	●								●		●	●			●				
MAN 200/4/100 A1DT/50	●								●		●	●			●				
MAN 300/4/100 A1FT/50	●								●		●	●			●				
MAN 400/4/100 A1FT/50	●								●		●	●			●				
MAN 150/6/80 A1DT/50	●								●		●	●			●				
MAN 150/6/100 A1DT/50	●								●		●	●			●				
MAN 250/6/100 A1FT/50	●								●		●	●			●				
MAN 250/6/150 A1FT/50	●								●		●	●			●				

NOTE FOR SINGLE PHASE PUMPS: thermal protections into the winding have to be connected to the electrical panel.
 Start capacitor inside the pump. Circuit breaker supplied but not connected to the pump cable.
 The use of an electrical panel as circuit breaker housing is mandatory.
 For installation please see use and maintenance instructions booklet.



MAN

Overall dimensions and weights

Models with vertical discharge

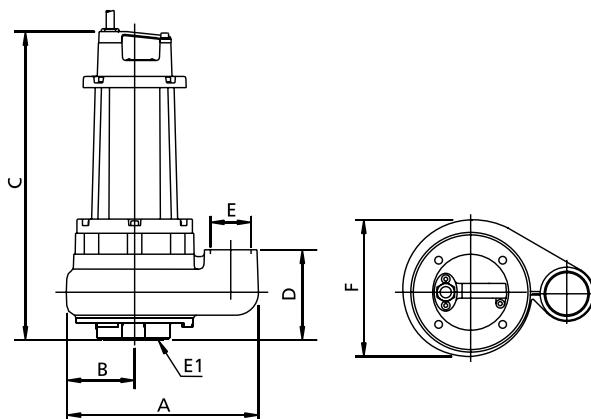

	A	B	C	D	E	E1 (*)	F	kg
MAN 250/2/G65V A1DM(T)/50	335	125	545	155	G 2 1/2"	65	240	52
MAN 300/2/G65V A1DT/50	335	125	545	155	G 2 1/2"	65	240	52

Dimensions in mm

(*) DN of the suction flange - PN6

All weights and dimensions are indicative only

Models with horizontal discharge

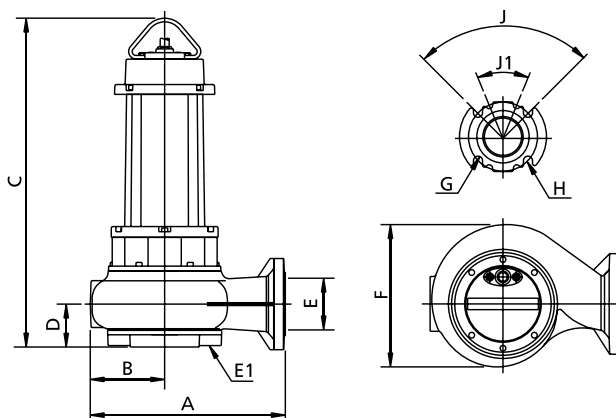

	A	B	C	D	E	E1 (*)	F	G	H	J	J1	kg
MAN 250/2/65 A1DM(T)50	340	135	545	80	65	65	255	18	145	90°	-	58
MAN 300/2/65 A1DT/50	340	135	545	80	65	65	255	18	145	90°	-	58
MAN 400/2/65 A1FT/50	340	135	685	80	65	65	260	18	145	90°	-	74
MAN 550/2/65 A1FT/50	340	135	685	80	65	65	260	18	145	90°	-	77
MAN 250/2/80 A1DM(T)/50	345	135	545	80	80	65	255	18	160	90°	45°	56
MAN 300/2/80 A1DT/50	345	135	685	80	80	65	260	18	160	90°	45°	58
MAN 400/2/80 A1FT/50	345	135	685	80	80	65	260	18	160	90°	45°	74
MAN 550/2/80 A1FT/50	345	135	685	80	80	65	260	18	160	90°	45°	77
MAN 400/2/100 A1FT/50	430	170	705	90	100	80	325	18	180	45°	-	82
MAN 550/2/100 A1FT/50	430	170	705	90	100	80	325	18	180	45°	-	85
MAN 200/4/80 A1DT/50	390	150	590	90	80	100	290	18	160	90°	45°	66
MAN 300/4/80 A1FT/50	390	150	700	90	80	100	290	18	160	90°	45°	86
MAN 400/4/80 A1FT/50	390	150	700	90	80	100	290	18	160	90°	45°	89
MAN 200/4/100 A1DT/50	415	160	595	90	100	100	310	18	180	45°	-	68
MAN 300/4/100 A1FT/50	415	160	700	90	100	100	310	18	180	45°	-	88
MAN 400/4/100 A1FT/50	415	160	700	90	100	100	310	18	180	45°	-	91
MAN 150/6/80 A1DT/50	390	150	595	90	80	100	290	18	160	90°	45°	65
MAN 150/6/100 A1DT/50	415	160	595	90	100	100	310	18	180	45°	-	67
MAN 250/6/100 A1FT/50	505	200	740	115	100	100	395	18	180	45°	-	111
MAN 250/6/150 A1FT/50	505	200	740	115	150	100	395	24	240	45°	-	114

Dimensions in mm

(*) DN of the suction flange - PN6

All weights and dimensions are indicative only

Packaging dimension

	A	B	C
MAN 250/2/G65V A1DM(T)/50	725	445	415
MAN 300/2/G65V A1DT/50	725	445	415
MAN 250/2/65 A1DM(T)/50	725	445	415
MAN 300/2/65 A1DT/50	725	445	415
MAN 400/2/65 A1FT/50	725	445	415
MAN 550/2/65 A1FT/50	725	445	415
MAN 250/2/80 A1DM(T)/50	725	445	415
MAN 300/2/80 A1DT/50	725	445	415
MAN 400/2/80 A1FT/50	725	445	415
MAN 550/2/80 A1FT/50	725	445	415
MAN 400/2/100 A1FT/50	725	445	415
MAN 550/2/100 A1FT/50	725	445	415
MAN 200/4/80 A1DT/50	725	445	415
MAN 300/4/80 A1FT/50	725	445	415
MAN 400/4/80 A1FT/50	725	445	415
MAN 200/4/100 A1DT/50	725	445	415
MAN 300/4/100 A1FT/50	725	445	415
MAN 400/4/100 A1FT/50	725	445	415
MAN 150/6/80 A1DT/50	725	445	415
MAN 150/6/100 A1DT/50	725	445	415
MAN 250/6/100 A1FT/50	725	445	415
MAN 250/6/150 A1FT/50	725	445	415

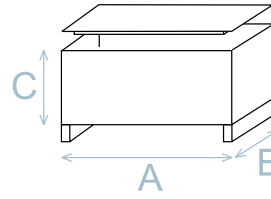

All weights and dimensions are indicative only

Dimension in mm

Installations available

