

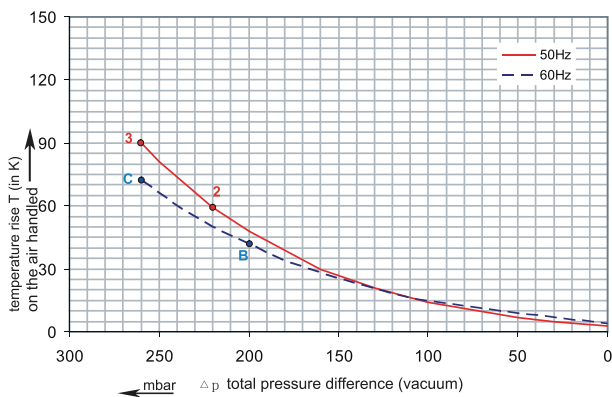

1RSCB 38-50

Performance curve for Vacuum pump

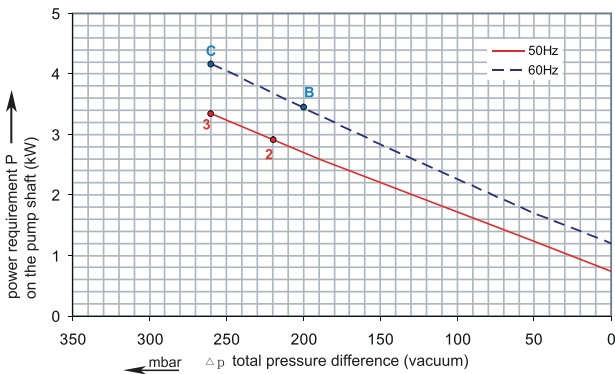
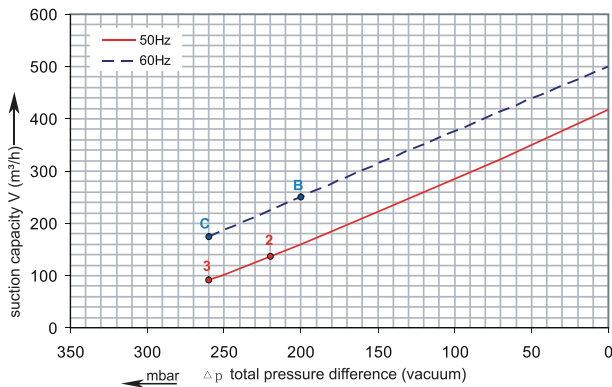

1RSCB 38-50

Performance curve for Compressor

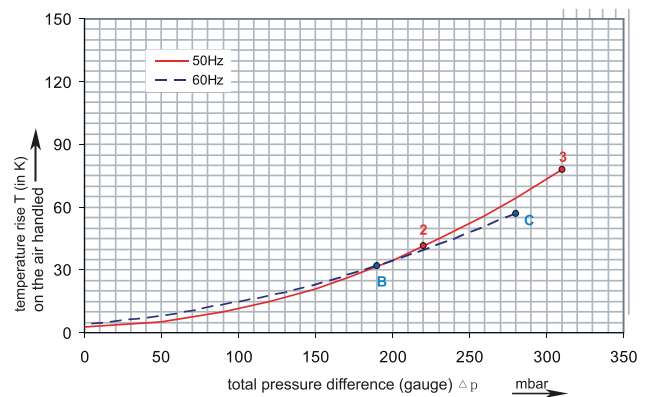
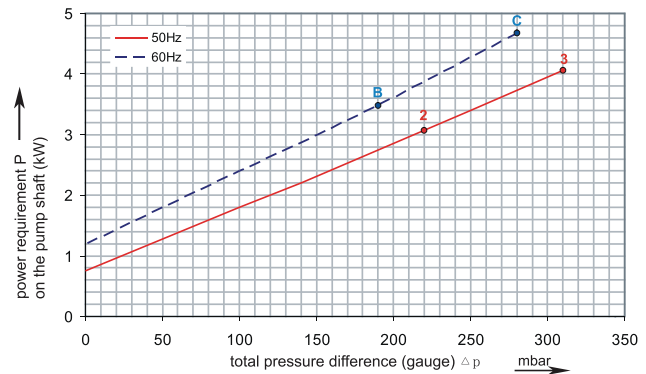
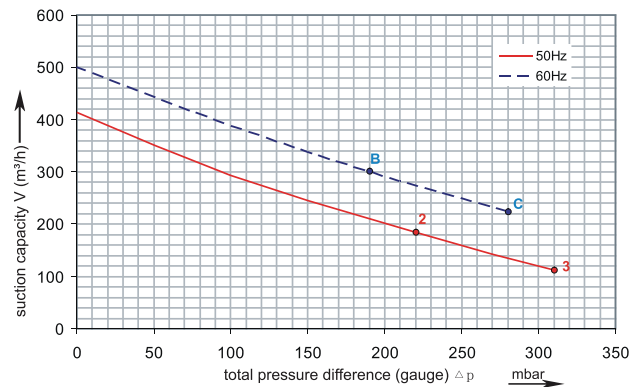

The performance curves are based on air at a temperature of 15 °C and an atmospheric pressure of 1013 mbar with a tolerance of +/- 10 %. The total pressure differences are valid for suction and ambient temperatures up to 25 °C. For other conditions please confer with us.

Each RSC type can be applied both as vacuum pump and compressor in continuous operation over the total stated performance curve range. The motors are available as standard for the input voltage range of 50 and 60 Hz and for protection category IP 55 as well as approved for UL and CSA.



Madan Technologies
Maagan Michael
D. N. Menashe
3780500 Israel

Tel: +972-4-6243353
Fax: +972-4-6243366
sales@madantec.com
www.madantec.com

RENOVA

1RSCB 38-50

Curve No.	Model	Freq. (Hz)	Rated power (KW)	Voltage (V)	Current (A)	Sound Level [dB(A)]	Weight (Kg)
2	1RSCB38-50 3.0T	50	3.0	200-240 Δ / 345-415Y	12.5 Δ / 7.2Y	70	37
B	1RSCB38-50 3.0T	60	3.45	220-275 Δ / 380-480Y	12.6 Δ / 7.3Y	73	37
3	1RSCB38-50 4.0T	50	4.0	345-415 Δ / 600-720Y	9.0 Δ / 5.2Y	70	43
C	1RSCB38-50 4.0T	60	4.6	380-480 Δ / 660-720Y	9.0 Δ / 5.2Y	73	43

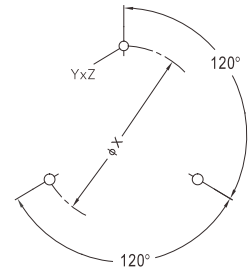
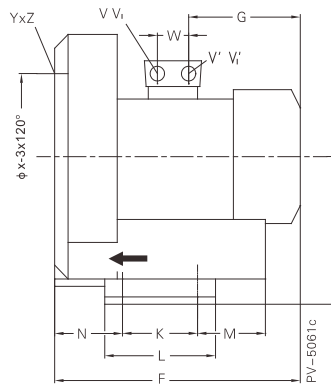
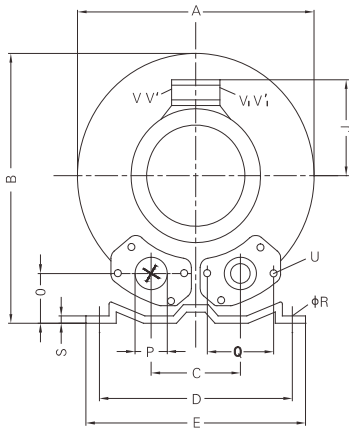

Model	A	B	C	D	E	F	G	H	J	K	L	M	N	O	ØP
1RSCB38-50 3.0T	382	384	125	290	325	419	189	197	135	140	180	84	109	54	2"
1RSCB38-50 4.0T	382	384	125	290	325	432	209	197	148	140	180	84	109	54	2"

Model	Q	ØR	S	U	YxZ	X-Holes	ØX
1RSCB38-50 3.0T	83	15	4.5	M8x17	M10x20	0°/120°/240°	240
1RSCB38-50 4.0T	83	15	4.5	M8x17	M10x20	0°/120°/240°	240