

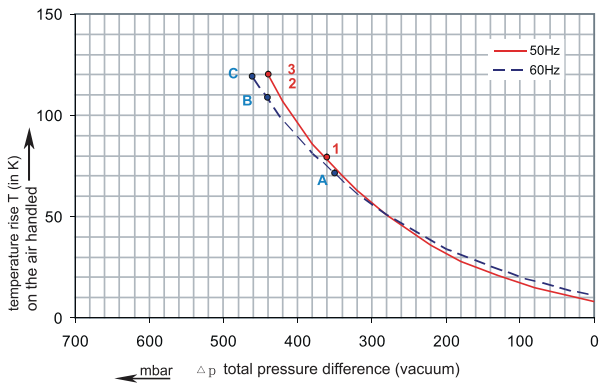

2RSC 43-50

Performance curve for Vacuum pump

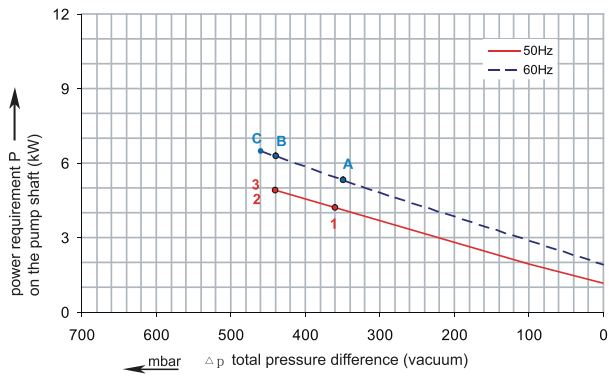
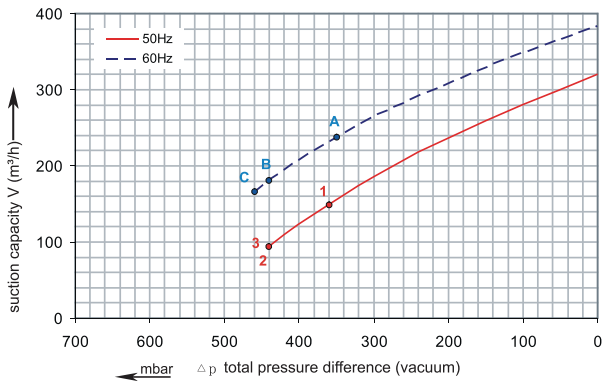

The performance curves are based on air at a temperature of 15 °C and an atmospheric pressure of 1013 mbar with a tolerance of +/- 10 %. The total pressure differences are valid for suction and ambient temperatures up to 25 °C. For other conditions please confer with us.

2RSC 43-50

Performance curve for Compressor

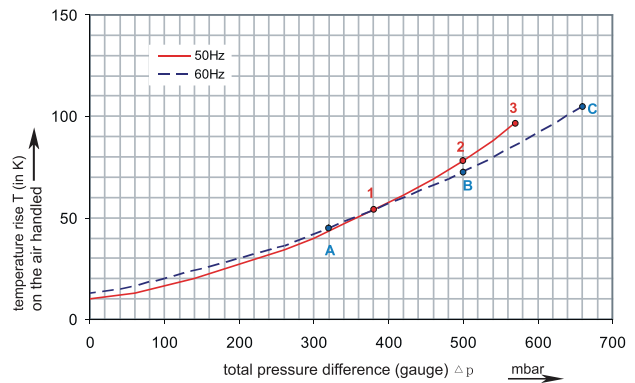
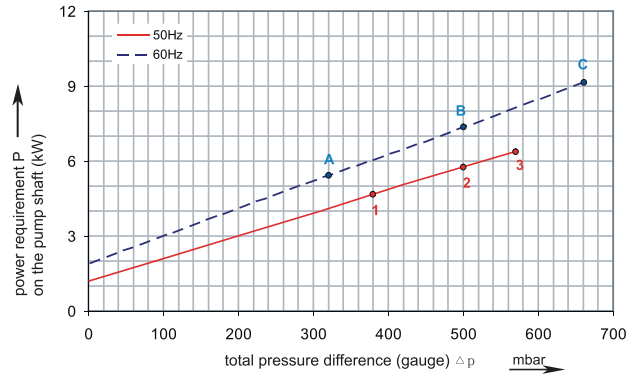
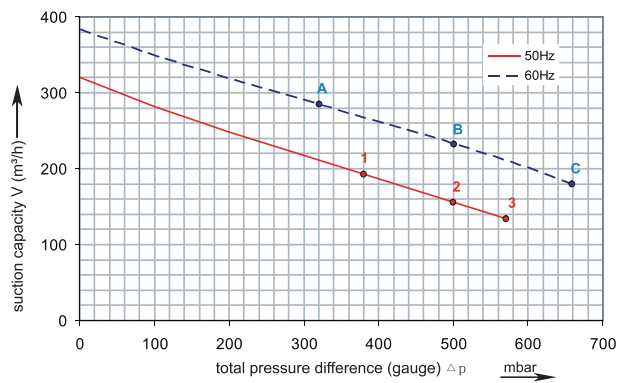

Each RSC type can be applied both as vacuum pump and compressor in continuous operation over the total stated performance curve range. The motors are available as standard for the input voltage range of 50 and 60 Hz and for protection category IP 55



Madan Technologies
Maagan Michael
D. N. Menashe
3780500 Israel

Tel: +972-4-6243353
Fax: +972-4-6243366
sales@madantec.com
www.madantec.com

RENOVA

2RSC 43-50

Curve No.	Model	Freq. (Hz)	Rated power (KW)	Voltage (V)	Current (A)	Sound Level [dB(A)]	Weight (Kg)
1	2RSC43-50 4.0T	50	4.3	345-415Δ / 600-720Y	10.0Δ / 5.2Y	73	54
A	2RSC43-50 4.0T	60	4.8	380-480Δ / 660-720Y	10.4Δ / 6.0Y	76	54
2	2RSC43-50 5.5T	50	5.5	345-415Δ / 600-720Y	13.3Δ / 7.7Y	73	66
B	2RSC43-50 5.5T	60	6.3	380-480Δ / 660-720Y	13.3Δ / 7.7Y	76	66
3	2RSC43-50 7.5T	50	7.5	345-415Δ / 600-720Y	16.7Δ / 9.6Y	73	73
C	2RSC43-50 7.5T	60	8.6	380-480Δ / 660-720Y	17.3Δ / 10.0Y	76	73

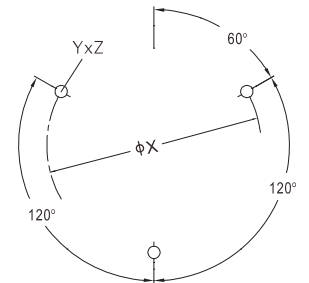
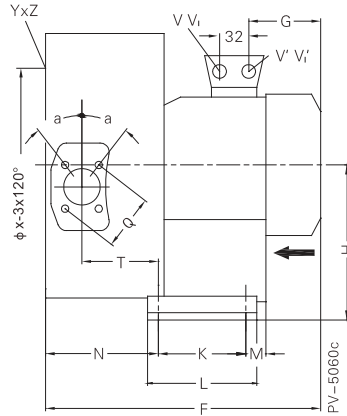
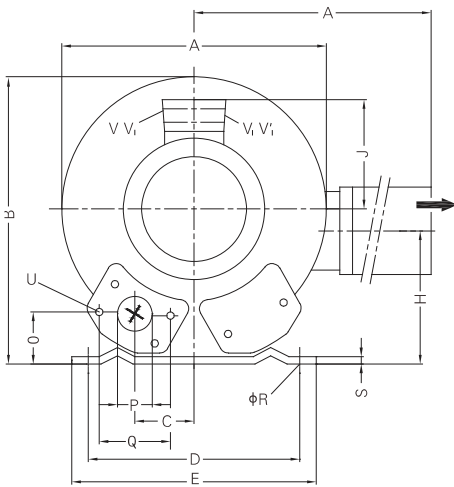

Model	A	A'	B	C	D	E	F	G	H	H'	J	K	L	M	N	O	ØP
2RSC43-50 4.0T	426	426	420	63	290	325	526	209	197	162	148	140	180	84	205	53	2"
2RSC43-50 5.5T	426	426	420	154	290	325	571	226	197	162	167	140	180	225	205	94	2"
2RSC43-50 7.5T	426	426	420	154	290	325	571	226	197	162	167	140	180	225	205	94	2"

Model	Q	ØR	S	T	U	ØX	YxZ	X-Holes
2RSC43-50 4.0T	83	15	4.5	130	M8x17	240	M10x20	51°/171°/291°
2RSC43-50 5.5T	83	15	4.5	130	M8x17	240	M10x20	51°/171°/291°
2RSC43-50 7.5T	83	15	4.5	130	M8x17	240	M10x20	51°/171°/291°